

Instructions for Use
Microwave

Bedienungsanweisung
Mikrowelle



Table of Contents

EN

1	PRECAUTIONS FOR USE	2
2	DISPOSAL INSTRUCTIONS - OUR ENVIRONMENT POLICY	3
3	SAFETY PRECAUTIONS	4
4	GET TO KNOW YOUR OVEN.....	8
5	BEFORE INSTALLATION	8
6	DESCRIPTION OF FRONT PANEL CONTROLS	9
7	USING THE OVEN.....	11
8	ACCESSORIES AVAILABLE	16
9	RECOMMENDED COOKING TABLES	24
10	CLEANING AND MAINTENANCE	24
11	EXTRAORDINARY MAINTENANCE	26
12	INSTALLING THE APPLIANCE.....	28

INSTRUCTIONS FOR THE USER: *these provide recommendations for use, a description of the controls and the correct procedures for cleaning and maintaining the appliance*



INSTRUCTIONS FOR THE INSTALLER: *these are intended for the qualified engineer who is to install, commission and test the appliance*



1 PRECAUTIONS FOR USE



THIS MANUAL IS AN INTEGRAL PART OF THE APPLIANCE. TAKE GOOD CARE OF IT AND KEEP IT TO HAND THROUGHOUT THE OVEN'S LIFE CYCLE. WE URGE YOU TO READ THIS MANUAL AND ALL THE INFORMATION IT CONTAINS CAREFULLY BEFORE USING THE APPLIANCE. INSTALLATION MUST BE CARRIED OUT BY QUALIFIED STAFF IN COMPLIANCE WITH THE RELEVANT REGULATIONS. THIS APPLIANCE IS INTENDED FOR HOUSEHOLD USE AND COMPLIES WITH THE EEC DIRECTIVES CURRENTLY IN FORCE. THE APPLIANCE IS BUILT TO PROVIDE THE FOLLOWING FUNCTION: COOKING AND HEATING FOODS; ALL OTHER USES ARE TO BE CONSIDERED IMPROPER. THE MANUFACTURER DECLINES ALL LIABILITY FOR USES OTHER THAN THOSE STATED ABOVE. KEEP THE DOCUMENTATION OF THIS PRODUCT FOR FUTURE REFERENCE. ALWAYS KEEP THE INSTRUCTION MANUAL HANDY. IF YOU LEND THE MICROWAVE OVEN TO SOMEONE ELSE GIVE THEM THE MANUAL AS WELL!



NEVER USE THIS APPLIANCE FOR HEATING ROOMS.



NEVER LEAVE PACKAGING RESIDUES UNATTENDED IN THE HOME. SEPARATE THE VARIOUS PACKAGING MATERIALS BY TYPE AND CONSIGN THEM TO THE NEAREST SEPARATE DISPOSAL CENTRE.



THIS APPLIANCE IS TAGGED UNDER EUROPEAN DIRECTIVE 2002/96/EC ON WASTE ELECTRICAL AND ELECTRONIC EQUIPMENT (WEEE). THIS DIRECTIVE CONTAINS THE REGULATIONS GOVERNING THE COLLECTION AND RECYCLING OF DECOMMISSIONED APPLIANCES THROUGHOUT THE EUROPEAN UNION.



NEVER OBSTRUCT THE OPENINGS AND SLITS PROVIDED FOR VENTILATION AND HEAT DISPERSAL.



THE NAMEPLATE WITH THE TECHNICAL DATA, SERIAL NUMBER AND MARK IS IN A VISIBLE POSITION ON THE OVEN DOOR FRAME. THE NAMEPLATE MUST NEVER BE REMOVED.



NEVER USE METAL SCOURING PADS OR SHARP SCRAPERS WHICH WILL DAMAGE THE SURFACE. USE ORDINARY NON-ABRASIVE PRODUCTS WITH THE AID OF WOODEN OR PLASTIC UTENSILS IF NECESSARY. RINSE THOROUGHLY AND DRY WITH A SOFT CLOTH OR CHAMOIS LEATHER. DO NOT ALLOW SPILLS OF FOODS WITH HIGH SUGAR CONTENT (E.G. JAM) TO DRY INSIDE THE OVEN. IF THEY DRY FOR TOO LONG, THEY MIGHT DAMAGE THE ENAMEL COATING OF THE INSIDE OF THE OVEN.





2 **DISPOSAL INSTRUCTIONS - OUR ENVIRONMENT POLICY**

Our products are only packaged using non-pollutant, environment-friendly, recyclable materials. We urge you to cooperate by disposing of the packaging properly. Contact your local dealer or the competent local organisations for the addresses of collection, recycling and disposal facilities.

Never leave all or part of the packaging lying around. Packaging parts, and especially plastic bags, may represent a suffocation hazard for children.

Your old appliance must also be disposed of properly.

Important: deliver the appliance to your local organisation authorised to collect scrapped appliances. Proper disposal allows the intelligent recovery of valuable materials.

Before scrapping your appliance it is important to remove doors and leave shelves in position as for use, to ensure that children cannot accidentally become trapped inside the oven during play. Also, cut the power supply lead and remove it and the plug.

Safety Precautions

3 SAFETY PRECAUTIONS



REFER TO THE INSTALLATION INSTRUCTIONS FOR THE SAFETY REGULATIONS FOR ELECTRIC OR GAS APPLIANCES AND VENTILATION FUNCTIONS.

IN YOUR INTEREST AND TO ENSURE YOUR SAFETY, BY LAW ALL ELECTRIC APPLIANCES MUST ONLY BE INSTALLED AND SERVICED BY QUALIFIED STAFF, IN ACCORDANCE WITH THE RELEVANT REGULATIONS. OUR APPROVED INSTALLATION ENGINEERS GUARANTEE YOU A JOB WELL DONE.

GAS OR ELECTRIC APPLIANCES MUST ALWAYS BE DISCONNECTED BY SUITABLY SKILLED PEOPLE.



THE PLUG TO BE CONNECTED TO THE POWER SUPPLY LEAD AND THE RELATIVE SOCKET MUST BE OF THE SAME TYPE AND COMPLY WITH THE RELEVANT REGULATIONS.

THE POWER SUPPLY SOCKET MUST BE ACCESSIBLE EVEN AFTER THE APPLIANCE HAS BEEN BUILT-IN.

NEVER DISCONNECT THE PLUG BY PULLING ON THE POWER SUPPLY LEAD



THE APPLIANCE MUST BE CONNECTED TO EARTH IN COMPLIANCE WITH ELECTRICAL SYSTEM SAFETY REGULATIONS.



IMMEDIATELY AFTER INSTALLATION, CARRY OUT A QUICK TEST ON THE OVEN FOLLOWING THE INSTRUCTIONS PROVIDED LATER IN THIS MANUAL. DURING THE TESTS PUT A GLASS OF WATER INSIDE THE OVEN AS IT WILL ABSORB THE MICROWAVES AND THE OVEN WILL NOT BE DAMAGED. IF THE APPLIANCE FAILS TO OPERATE, DISCONNECT IT FROM THE ELECTRICAL MAINS AND CONTACT YOUR NEAREST SERVICE CENTRE. NEVER ATTEMPT TO REPAIR THE APPLIANCE.



WARNING! NEVER LEAVE THE OVEN UNWATCHED, ESPECIALLY WHEN USING PAPER, PLASTIC OR OTHER COMBUSTIBLE MATERIALS. THESE MATERIALS CAN CHAR AND MAY FIRE. FIRE RISK!

WARNING! IF YOU SEE SMOKE OR FIRE, KEEP THE DOOR CLOSED IN ORDER TO SMOTHER THE FLAMES. SWITCH OFF THE OVEN AND TAKE THE PLUG OUT OF THE SOCKET OR CUT OFF THE OVEN POWER SUPPLY.

WARNING! DO NOT HEAT PURE ALCOHOL OR ALCOHOLIC DRINKS IN THE MICROWAVE. FIRE RISK!

WARNING! DO NOT HEAT LIQUIDS OR OTHER FOODS IN CLOSED CONTAINERS SINCE THESE MAY EXPLODE READILY.



WARNING! THIS APPLIANCE IS NOT INTENDED FOR USE BY PERSONS (INCLUDING CHILDREN) WITH REDUCED PHYSICAL, SENSORY OR MENTAL CAPABILITIES, OR LACK OF EXPERIENCE AND KNOWLEDGE, UNLESS THEY HAVE BEEN GIVEN SUPERVISION OR INSTRUCTION CONCERNING USE OF THE APPLIANCE BY A PERSON RESPONSIBLE FOR THEIR SAFETY. CHILDREN SHOULD BE SUPERVISED TO ENSURE THAT THEY DO NOT PLAY WITH THE APPLIANCE.

Safety Precautions

EN



WARNING! IF THE OVEN HAS A COMBINED FUNCTION MODE (MICROWAVE WITH OTHER MEANS OF HEATING), CHILDREN SHOULD NOT BE ALLOWED TO USE THE OVEN WITHOUT ADULT SUPERVISION ON ACCOUNT OF THE HIGH TEMPERATURES GENERATED.

WARNING: ACCESSIBLE PARTS MAY BECOME HOT DURING USE. YOUNG CHILDREN SHOULD BE KEPT AWAY.

WARNING: DURING USE THE APPLIANCE BECOMES HOT. CARE SHOULD BE TAKEN TO AVOID TOUCHING HEATING ELEMENTS INSIDE THE OVEN.

WARNING! THE OVEN CANNOT BE USED IF:

- THE DOOR IS NOT CLOSED CORRECTLY;
- THE DOOR HINGES ARE DAMAGED;
- THE SURFACES OF THE CONTACT BETWEEN THE DOOR AND THE OVEN FRONT ARE DAMAGED;
- THE DOOR WINDOW GLASS IS DAMAGED;
- THERE IS FREQUENT ELECTRICAL ARCING INSIDE THE OVEN EVEN THOUGH THERE IS NO METAL OBJECT INSIDE.

THE OVEN **CAN ONLY BE USED AGAIN** AFTER IT HAS BEEN REPAIRED BY A TECHNICAL ASSISTANCE SERVICE TECHNICIAN.



BEWARE!

NEVER HEAT BABY FOODS OR DRINKS IN BOTTLES OR JARS WITH THE TEATS OR LIDS ON THEM. AFTER HEATING THE FOOD MIX OR SHAKE WELL SO THAT THE HEAT IS SPREAD EVENLY. CHECK THE FOOD TEMPERATURE BEFORE FEEDING THIS TO THE CHILD. DANGER OF BURNING!



TAKE CARE WHEN HEATING LIQUIDS!

WHEN LIQUIDS (WATER, COFFEE, TEA, MILK, ETC.) ARE NEARLY AT BOILING POINT INSIDE THE OVEN AND ARE TAKEN OUT SUDDENLY, THEY MAY SPURT OUT OF THEIR CONTAINERS. DANGER OF INJURIES AND BURNS!



TO AVOID THAT TYPE OF SITUATION WHEN HEATING LIQUIDS, PUT A TEASPOON OR GLASS ROD INSIDE THE CONTAINER.

TO AVOID FOOD OVERHEATING OR BURNING IT IS VERY IMPORTANT NOT TO SELECT LONG TIME PERIODS OR POWER LEVELS THAT ARE TOO HIGH WHEN HEATING SMALL QUANTITIES OF FOOD. FOR EXAMPLE, A BREAD ROLL CAN BURN AFTER 3 MINUTES IF THE POWER SELECTED IS TOO HIGH. FOR TOASTING, USE JUST THE GRILLING FUNCTION AND WATCH THE OVEN ALL THE TIME. IT YOU USE A COMBINED FUNCTION TO TOAST BREAD IT WILL CATCH FIRE IN A VERY SHORT TIME.



THIS OVEN IS EXCLUSIVELY FOR DOMESTIC USE!

USE THE OVEN ONLY FOR PREPARING MEALS.

AVOID DAMAGING THE OVEN OR OTHER DANGEROUS SITUATIONS BY FOLLOWING THESE INSTRUCTIONS:

- Do not switch on the oven **without** the turntable support, the turntable ring and the respective plate being in place.
- **Never switch on the microwave when it is empty.** If there is no food inside there may be an electrical overcharge and the oven could be damaged. **RISK OF DAMAGE!**
- Do not cover or obstruct the **ventilation openings.**

Safety Precautions

EN

- Use only **dishes suitable** for microwaves. Before using dishes and containers in the microwave, check that these are suitable (see the section on types of dishes).
- **Never remove the mica cover on the ceiling of the oven interior!** This cover stops fat and pieces of food damaging the microwave generator.
- Do not keep any **inflammable object** inside the oven as it may burn if the oven is switched on.
- Do not use the oven as a **pantry**.
- **Eggs with their shells** and **whole boiled eggs** must not be heated in microwave ovens because they may explode.
- Do not use the oven for **frying** as it is impossible to control the temperature of oil heated by microwaves.
- **To avoid being burnt**, always use oven gloves for handling dishes and containers and touching the oven.
- **Do not lean or sit on the open oven door.** This may damage the oven, especially in the hinge zone. The door can bear a maximum weight of 8 kg.
- The turntable and the grills can bear a **maximum load of 8 kg**. To avoid damaging the oven, do not exceed this load.

CLEANING:

- **Warning!** Your microwave oven must be cleaned regularly. All food remains must be removed (see section on Oven Cleaning). If the microwave oven is not kept clean its surface may deteriorate and **this may shorten the oven's working life and could even result in a dangerous situation.**
- The door contact surfaces (the front of the cavity and the inside part of the doors) must be kept very clean in order to ensure the oven functions correctly.
- **DO NOT USE HARSH ABRASIVE CLEANERS OR SHARP METAL SCRAPERS TO CLEAN THE OVEN DOOR GLASS SINCE THEY CAN SCRATCH THE SURFACE, WHICH MAY RESULT IN SHATTERING OF THE GLASS.**
- Please follow the instructions regarding cleaning in the section "Oven Cleaning and Maintenance".

Safety Precautions

EN

REPAIRS:

- **Warning – Microwaves! The outer protection of the oven must not be removed.** It is dangerous for anyone not authorised by the manufacturer to carry out any kind of repair or maintenance work.
- If the power cable is damaged it should be substituted by the manufacturer, authorised agents or technicians qualified for this task in order to avoid dangerous situations. Furthermore, special tools are required for this task.
- Repair and maintenance work, especially of current carrying parts, can only be carried out by technicians authorised by the manufacturer.



The manufacturer declines all responsibility for injury or damage caused by failure to comply with the above regulations or deriving from tampering with even just one part of the appliance and the use of non-original spare parts.



Instructions for the User

EN

4 GET TO KNOW YOUR OVEN

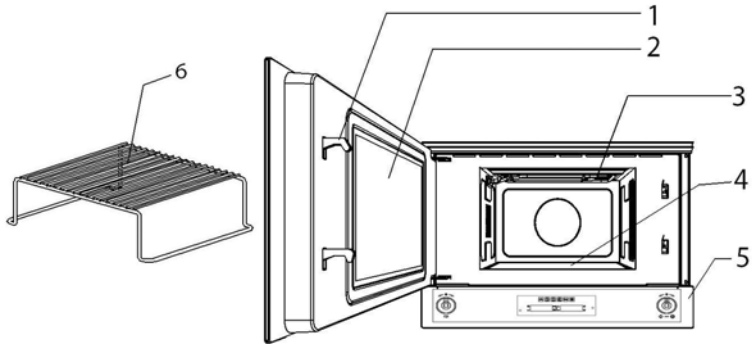

- | | |
|----------------------|------------------|
| 1. Catches | 4. Ceramic base |
| 2. Door window glass | 5. Control panel |
| 3. Drop-down grill | 6. Rack |

5 BEFORE INSTALLATION



Never leave packaging residues unattended in the home. Separate waste packaging materials by type and consign them to the nearest separate disposal centre.



The inside of the appliance should be cleaned to remove all manufacturing residues. For further information about cleaning, see point "10. CLEANING AND MAINTENANCE".



6 DESCRIPTION OF FRONT PANEL CONTROLS

All the appliance's control and monitoring devices are placed together on the front panel. The table below provides the key to the symbols used.

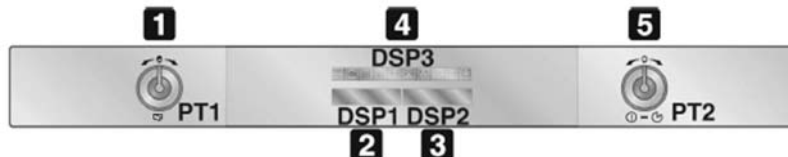

1
PT1

FUNCTION'S PARAMETERS KNOB

This knob allows you to open the door and set the time, select the cooking temperature and duration and program the cooking start and end times. From now on, for convenience it will be referred to as PT1. For instructions on how to use it correctly, see the next chapters.

Note: Parameter knob allows you to open the door by pressing it for approx. 3 seconds

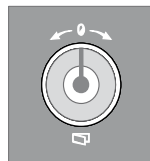

2
DSP1

CURRENT TIME / DURATION DISPLAY

This display shows the current time or the cooking duration. Also visible are the function safety lock-out light (see point "7.7.3 Child safety lock-out function")

From now on, for convenience it will be referred to as DSP1.

3
DSP2

MICROWAVES POWER / WEIGHT DISPLAY

This display shows the Parameters set for the function required, or the Parameters set by the user.

From now on, for convenience it will be referred to as DSP2.

4
DSP3

FUNCTION DISPLAY

This display shows (illuminated) all the cooking functions available for selection. For instructions on how to select a cooking function, see point "7.2 Operating settings".

From now on, for convenience it will be referred to as DSP3.



Instructions for the User

EN

5
PT2

FUNCTION-SWITCH ON KNOB

This knob allows the switching on and off of the microwave, and is also used to select a cooking function (see point "7.2 Operating settings").
From now on, for convenience it will be referred to as PT2.
 The table below provides a short description of the functions available.



MICROWAVES



DEFROST BY TIME



MICROWAVES + GRILL ELEMENT



DEFROST BY WEIGHT



GRILL ELEMENT



PIZZA FUNCTION

STAND-BY MODE

The Displays shows only the current time.



ON MODE



OFF MODE





7 USING THE OVEN

7.1 Precautions and General Advice



When the oven and grill are used for the first time, they should be heated to the maximum temperature for long enough to burn off any oily residues left by the manufacturing process, which might contaminate foods with unpleasant smells.



Oven accessories which may come into contact with foods are made from materials compliant with directive 89/109/EEC of 21/12/88 and national relevant regulations.



To prevent excessive amounts of condensation from forming on the internal glass, food should not be left inside the oven for too long after cooking.

7.2 Operating settings

This product is programmed to provide 3 operating settings, which can be modified by pressing PT2.

Standby setting: activated as soon as the current time has been confirmed, with DSP1 on and showing the current time.

ON setting: from the standby setting, press PT2 once. All the displays and knobs light up.

OFF setting: from the ON setting, press PT2 once.

Only the symbol  on DSP1 remains on.

The heating system is not activated immediately in any of these functions, in order to improve operator safety.

7.3 First Use

At first use, or after a power failure, the oven's left hand-display, DSP1, will show a flashing  symbol. To start any cooking operation, the current time must be set.

7.3.1 Setting the current time

Press PT 1 for 3 seconds to set the current time, turn PT1 to the right and left to increase or decrease the hours. Press it once to move on to setting the minutes. Turn it the right and left to increase or decrease the hours and press it to set the current time. The symbol  will appear on the display, which will stop flashing. Press PT1 again and the minutes will Flash, turn right left to set the minutes. Press PT and the time is set.

7.3.2 Setting the current time

It might become necessary to change the current time, for example at the switch from summer to winter time. To do this, start from the standby setting (see point "7.2 Operating settings"). Now repeat the operations described in point "7.3.1 Setting the current time".



Instructions for the User

EN

7.4 *Opening the door*

To open the door press PT1 briefly.

7.5 *Selecting the function*

In the ON state only, a cooking function can be selected by simply turning PT2 to the right or left. The function selected will change colour to orange on DSP3. The preset cooking time will be displayed on DSP1 and the preset parameters (temperature, microwaves power, weight) are displayed in alternation on DSP2.

7.5.1 *Microwaves function*

After selecting this function, turn PT1 to the right or left to change the preset cooking duration.

Press PT1 for 3 seconds to validate and the microwaves power light **W** starts to blink.

Turn PT1 to the right or left to change the preset microwaves power.

Press PT2 to immediately start the cooking process or otherwise press PT1 for 3 seconds to set a different time for the cooking process start (please refer to point "7.5.7 Delayed Start Time (Automatic cooking)").

7.5.2 *Microwaves+ Grill Element function*

After selecting this function, turn PT1 to the right or left to change the preset cooking duration.

Press PT1 for 3 seconds to validate and the microwaves power light **W** starts to blink.

Turn PT1 to the right or left to change the preset microwaves power.

Press PT2 to immediately start the cooking process or otherwise press PT1 for 3 seconds to set a different time for the cooking process start (please refer to point "7.5.7 Delayed Start Time (Automatic cooking)").

7.5.3 *Grill Element function*

After selecting this function, turn PT1 to the right or left to change the preset cooking duration.

Press PT2 to immediately start the cooking process or otherwise press PT1 to set a different time for the cooking process start (please refer to point "7.5.7 Delayed Start Time (Automatic cooking)").

7.5.4 *Defrost by Time function*

After selecting this function, turn PT1 to the right or left to change the preset defrosting duration.

Press PT2 to start the defrosting process.

The microwaves power will be automatically varied to achieve the best thawing results.

7.5.5 *Defrost by Weight function*

After selecting this function, turn PT1 to the right or left to change the preset food type displayed on DSP1.

Instructions for the User



EN

Press PT1 for 3 seconds to validate and the weight light  starts to blink.

Turn PT1 to the right or left to change the preset food weight.

Press PT2 to start the defrosting process.

The defrosting time will be calculated based on the food's type and weight and the microwaves power will be automatically varied to achieve the best thawing results.

The following table shows the defrosting by weight function programmes, indicating weight intervals, and defrosting and standing times (in order to ensure the food is of a uniform temperature).

PROGRAMME	FOOD	WEIGHT (G)	TIME (MIN)	STANDING TIME (MIN)
PR 01	MEAT	100 – 2000	2 – 43	20 – 30
PR 02	POULTRY	100 – 2500	2 – 58	20 – 30
PR 03	FISH	100 – 2000	2 – 40	20 – 30
PR 04	FRUIT	100 – 500	2 – 13	10 – 20
PR 05	BREAD	100 – 800	2 – 19	10 – 20

7.5.6 Pizza function

After selecting this function, the weight light  starts to blink.

Turn PT1 to the right or left to change the preset Pizza weight.

Press PT2 to start the cooking process.

7.5.7 Delayed Start Time (Automatic cooking)

When PT1 is pressed to define a delayed start time the corresponding light  starts to blink, DSP1 shows the current time and DSP 2 shows "Auto".

Turn PT1 to the right or left to change the delayed start time.

Press PT2 to validate the delayed start time.

The oven enters in an idle state waiting for the defined start time. DSP3 shows the selected function and DSP1 and DSP2 show all the defined parameters for the function continuously alternating.

If you wish to start the function before the selected time, just press PT2.

If you wish to cancel the programming, press PT2 for 3 seconds.

7.6 When the oven is working...

7.6.1 Interrupting a cooking cycle

You can stop the cooking process at any time by pressing the Start/Stop key once or by opening the oven door. In both cases:

- **Microwave emission is stopped immediately.**
- The grill is de-activated but is **still very hot. Danger of burning!**
- The timer stops and the display shows the remaining amount of operating time.

If you wish, at this time you can:

- Turn or stir the food to ensure it will be evenly cooked.
- Modify the process parameters.
- Cancel the process by pressing PT2 for 3 seconds.

To restart the process, close the door and press PT2.



Instructions for the User

7.6.2 **Modifying parameters**

The operating parameters (time, weight, power, etc.) can only be modified when the cooking process has been interrupted. Proceed as follows:

- Press PT1 approximately 5-6 seconds to activate the parameter modification mode. The **min** symbol starts to blink. Turn PT1 to the right or left to change the remaining cooking duration.
- Press PT1 for 3 seconds to validate and the next parameter light starts to blink. Proceed as described in the active function chapter to modify the remaining parameters.
- Press PT2 to continue the cooking process.

7.6.3 **Cancelling a cooking cycle**

If you wish to cancel the cooking process, press PT2 for 3 seconds. You will then hear a beep and the oven returns to the OFF setting.

7.6.4 **End of a cooking cycle**

At the end of the process you will hear three beeps and the display will show the word "End".

The beeps are repeated every 30 seconds until the door is opened or PT2 is pressed. The oven returns to the OFF setting.

7.7 **Secondary menu**

This appliance also has a concealed "secondary menu" allowing the user to:

1. Activate or deactivate the Show Room function (which disables all the heating elements so that only the control panel works);
2. Activate or deactivate the function which limits the maximum power absorption to 2000 W;
3. Activate or deactivate the child safety device (

7.7.1 **Show Room Function**

With the oven in OFF status (see point "7.2 Operating settings") keep PT1 pressed between 5-6 seconds, until the message OFF SHO appears on DSP1. This means that the SHOW ROOM function (which disables all the heating elements so that only the control panel works) is not active.

Turn PT1 to the right or left to activate (ON SHO) or deactivate (OFF SHO) this function. To use the oven normally, set OFF SHO.

After setting the parameter required, press PT2 to return the oven to the initial standby status.

7.7.2 **Child safety lock-out function**

With the oven in OFF status (see point "7.2 Operating settings") keep PT1 pressed until the message OFF SHO appears on DSP1. Now press PT1 until the message "OFF BLOC" appears on DPS1.

Turn PT1 to the right or left to activate (ON BLOC) or deactivate (OFF BLOC) this function, which locks out all the functions and knobs after 3 minutes of operation without any command from the user (when this system is active, the  symbol appears on DPS2).

After setting the parameter required, press PT2 to return the oven to the initial standby status.



To exit the lockout status temporarily to modify a cooking program or select a different function, keep PT1 pressed until the  symbol disappears from DSP2. The required changes can now be made, and 2 minutes after the last setting is made the lockout will come into operation again.

To deactivate the lockout permanently, access the secondary menu and switch the function off as described in this section.

7.8 Cooling fan system

The appliance is equipped with a cooling system which comes into operation as soon as a cooking function starts.

Operation of the fans generates a normal air flow which comes out above the door and may continue for a short time even after the oven is switched off.

7.9 Inside light

The oven light comes on:

- when the oven door is opened in standby status (point “7.2 Operating settings”) or;
- when the function knob is turned to any function.

If the oven door is left open, the oven light will automatically shut-off after 10 minutes.



Instructions for the User

8 ACCESSORIES AVAILABLE

Rack: useful for grilling thin foods useful for grilling foods or other general uses.



9 RECOMMENDED COOKING TABLES

9.1 Cooking with Microwaves



Warning! Read the section “Safety Precautions” before cooking with your microwave.

Follow these recommendations when cooking with microwaves:

- Before heating or cooking foods with peel or skin (e.g. apples, tomatoes, potatoes, sausages) prick them so that they do not burst. Cut the food up before starting to prepare it.
- Before using a container or dish make sure that it is suitable for microwave use (see the section on types of ovenware).
- When cooking food with very little moisture (e.g. defrosting bread, making popcorn, etc.) evaporation is very quick. The oven then works as if it was empty and the food may burn. The oven and the container may be damaged in such a situation. You should therefore set just the cooking time necessary and you must keep a close eye on the cooking process.
- It is not possible to heat large quantities of oil (frying) in the microwave.
- Remove pre-cooked food from the containers they come in since these are not always heat resistant. Follow the food manufacturer’s instructions.
- If you have several containers, such as cups, for example, set them out uniformly on the turntable plate.
- Do not close plastic bags with metal clips. Use plastic clips instead. Prick the bags several times so that the steam can escape easily.
- When heating or cooking foods, check that they reach at least a temperature of 70°C.
- During cooking, steam may form on the oven door window and may start to drip. This situation is normal and may be more noticeable if the room temperature is low. The oven’s safe working is not affected by this. After you have finished cooking, clean up the water coming from the condensation
- When heating liquids, use containers with a wide opening, so that the steam can evaporate easily.

Prepare the foods as per the instructions and keep in mind the cooking times and power levels indicated in the tables.

Keep in mind that the figures given are only indicative and can vary depending on the initial state, temperature, moisture and type of food. It is

Instructions for the User



EN

advisable to adjust the times and power levels to each situation. Depending on the exact characteristics of the food you may need to increase or shorten the cooking times or increase or decrease the power levels.

Cooking with microwaves...

1. The greater the amount of food, the longer the cooking time. Keep in mind that:

- Double the quantity » double the time
- Half the quantity » half the time

2. The lower the temperature, the longer the cooking time.

3. Foods containing a lot of liquid heat up more quickly.

4. Cooking will be more uniform if the food is evenly distributed on the ceramic base. If you put dense foods on the outside part of the plate and less dense ones on the centre of the plate, you can heat up different types of food simultaneously.

5. You can open the oven door at any time. When you do this the oven switches off automatically. The microwave will only start working again when you close the door and press the start key.

6. Foods that are covered require less cooking time and retain their characteristics better. The lids used must let microwaves pass through and have small holes that allow steam to escape

9.1.1 Cooking vegetables

FOOD	QUANTITY (GR)	LIQUIDS ADDITION	POWER (W)	TIME (MIN.)	STANDING TIME (MIN.)	INSTRUCTIONS
CAULIFLOWER	500	100 ML	800	9-11	2-3	CUT INTO SLICES.
BROCCOLI	300	50 ML	800	6-8	2-3	
MUSHROOMS	250	25 ML	800	6-8	2-3	KEEP COVERED.
PEAS, CARROTS	300	100 ML	800	7-9	2-3	CUT INTO CHUNKS OR SLICES. KEEP COVERED.
FROZEN CARROTS	250	25 ML	800	8-10	2-3	
POTATOES	250	25 ML	800	5-7	2-3	PEEL AND CUT INTO EQUAL SIZED PIECES. KEEP COVERED.
PAPRIKA	250	25 ML	800	5-7	2-3	CUT INTO CHUNKS
LEEK	250	50 ML	800	5-7	2-3	OR SLICES KEEP COVERED.
FROZEN BRUSSEL SPROUTS	300	50 ML	800	6-8	2-3	KEEP COVERED.

9.1.2 Cooking fish

FOOD	QUANTITY (G)	POWER (W)	TIME (MIN.)	STANDING TIME (MIN.)	INSTRUCTIONS
FISH FILLETS	500	600	10-12	3	COOK COVERED OVER. TURN AFTER HALF OF COOKING TIME.
WHOLE FISH	800	800 400	2-3 7-9	2-3	COOK COVERED OVER. TURN AFTER HALF OF COOKING TIME. YOU MAY WISH TO COVER UP THE SMALL EDGES OF THE FISH.



Instructions for the User

9.2 Defrosting with Microwaves



EN

General instructions for defrosting

1. When defrosting, use only dishes that are appropriate for microwaves (china, glass, suitable plastic).
2. The defrost function by weight and the tables refer to the defrosting of raw food.
3. The defrosting time depends on the quantity and thickness of the food. When freezing food keep the defrosting process in mind. Distribute the food evenly in the container.
4. Distribute the food as best as possible inside the oven. The thickest parts of fish or chicken drumsticks should be turned towards the outside. You can protect the most delicate parts of food with pieces of aluminium foil. Important: The aluminium foil must not come into contact with the oven cavity interior as this can cause electrical arcing.
5. Thick portions of food should be turned several times.
6. Distribute the frozen food as evenly as possible since narrow and thin portions defrost more quickly than the thicker and broader parts.
7. Fat-rich foods such as butter, cream cheese and cream should not be completely defrosted. If they are kept at room temperature they will be ready to be served in a few minutes. With ultra-frozen cream, if you find small pieces of ice in it, you should mix these in before serving.
8. Place poultry on an upturned plate so that the meat juices can run off more easily.
9. Bread should be wrapped in a napkin so that it does not become too dry.
10. Turn the food whenever the oven lets out a beep and the DSP1 displays the word: `turn`.
11. Remove frozen food from its wrapping and do not forget to take off any metal twist-tags. For containers that are used to keep frozen food in the freezer and which can also be used for heating and cooking, all you need to do is take off the lid. For all other cases you should put the food into containers that are suitable for microwave use.
12. The liquid resulting from defrosting, principally that from poultry, should be discarded. In no event should such liquids be allowed to come into contact with other foods.
13. Do not forget that by using the defrosting function you need to allow for standing time until the food is completely defrosted.

Instructions for the User



EN

The table below shows different defrosting and standing times (in order to ensure the food temperature is evenly distributed) for different types and weights of food, plus recommendations.

FOOD	WEIGHT (G)	DEFROSTING TIME (MIN)	STANDING TIME (MIN)	RECOMMENDATION
PORTIONS OF MEAT, VEAL, BEEF, PORK	100	2-3	5-10	TURN ONCE
	200	4-5	5-10	TURN ONCE
	500	10-12	10-15	TURN TWICE
	1000	21-23	20-30	TURN TWICE
	1500	32-34	20-30	TURN TWICE
	2000	43-45	25-35	TURN THREE TIMES
GOULASH	500	8 -10	10-15	TURN TWICE
	1000	17-19	20-30	TURN THREE TIMES
MINCED MEAT	100	2-4	10-15	TURN TWICE
	500	10-14	20-30	TURN THREE TIMES
SAUSAGES	200	4-6	10-15	TURN ONCE
	500	9-12	15-20	TURN TWICE
POULTRY (PORTIONS) CHICKEN	250	5-6	5-10	TURN ONCE
	1000	20-24	20-30	TURN TWICE
POULARDE	2500	38-42	25-35	TURN THREE TIMES
FISH FILLET	200	4-5	5-10	TURN ONCE
TROUT	250	5-6	5-10	TURN ONCE
PRAWNS	100	2-3	5-10	TURN ONCE
	500	8-11	15-20	TURN TWICE
	1000	11-14	20-30	TURN TWICE
FRUIT	200	4-5	5-10	TURN ONCE
	300	8-9	5-10	TURN ONCE
	500	11-14	10-20	TURN TWICE
BREAD	200	4-5	5-10	TURN ONCE
	500	10-12	10-15	TURN ONCE
	800	15-17	10-20	TURN TWICE
BUTTER	250	8-10	10-15	
CREAM CHEESE	250	6-8	10-15	
CREAMS	250	7-8	10-15	



Instructions for the User



9.3 Cooking with the Grill Element

For good results with the grill, use the rack supplied with the oven. Fit the rack in such a way that it doesn't come into contact with the metal surfaces of the oven cavity since if it does there is a danger of electric arcing which may damage the oven.

IMPORTANT POINTS:

1. When the grill is used for the first time there will be some smoke and a smell coming from the oils used during oven manufacture.
2. The oven door window becomes very hot when the grill is working. Keep children away.
3. When the grill is operating, the cavity walls and the grid iron become very hot. You should use oven gloves.
4. If the grill is used for extended period of time it is normal to find that the elements will switch themselves off temporarily due to the safety thermostat.
5. Important! When food is to be grilled or cooked in containers you must check that the container in question is suitable for microwave use. See the section on types of ovenware!
6. When the grill is used it is possible that some splashes of fat may go onto the elements and be burnt. This is a normal situation and does not mean there is any kind of operating fault.
7. After you have finished cooking, clean the interior and the accessories so that cooking remains do not become encrusted.

9.3.1 Grill Element



FISH	QUANTITY (G)	TIME (MIN.)	INSTRUCTIONS
FISH			
BASS	800	18-24	SPREAD LIGHTLY WITH BUTTER. AFTER HALF OF COOKING TIME TURN AND SPREAD WITH SEASONING.
SARDINES/GURNARD	6-8 FISH.	15-20	
MEAT			
SAUSAGES	6-8 UNITS	22-26	PRICK AFTER HALF COOKING TIME AND TURN.
FROZEN HAMBURGERS	3 UNITS	18-20	
SPARE RIB (APPROX. 3 CM THICK)	400	25-30	AFTER HALF OF COOKING TIME, BASTE AND TURN.
OTHERS			
TOAST	4 UNITS	1½-3	WATCH TOASTING.
TOASTED SANDWICHES	2 UNITS	5-10	WATCH TOASTING.

Heat up the grill beforehand for 2 minutes. Unless indicated otherwise, use the rack. Place a tray below the rack so that the water and the fat can drop. The times shown are merely indicative and can vary as a function of the composition and quantity of the food, as well as the final condition wished for. Fish and meat taste great if, before grilling, you brush them with vegetable oil, spices and herbs and leave to marinate for a few hours. Only add salt after grilling.

Instructions for the User



EN

Sausages will not burst if you prick them with a fork before grilling. After half the grilling time has passed, check on how the cooking is going and, if necessary, turn the food over.

The grill is especially suitable for cooking thin portions of meat and fish. Thin portions of meat only need to be turned once, but thicker portions should be turned several times. Heat up the grill beforehand for 2 minutes.

9.3.2 Microwaves + Grill Element

The microwave + grill function is ideal for cooking quickly and, at the same time, browning foods. Furthermore, you can also grill and cook cheese covered food.

The microwave and the grill work simultaneously. The microwave cooks and the grill toasts.

FOOD	QUANTITY (G)	DISH	POWER (W)	TIME (MIN.)	STANDING TIME (MIN.)
CHEESE TOPPED PASTA	500	LOW DISH	400	12-17	3-5
CHEESE TOPPED POTATOES	800	LOW DISH	600	20-22	3-5
LASAGNE	APPROX. 800	LOW DISH	600	15-20	3-5
GRILLED CREAM CHEESE	APPROX. 500	LOW DISH	400	18-20	3-5
2 FRESH CHICKEN LEGS (GRILLED)	200 EACH	LOW DISH	400	10-15	3-5
CHICKEN	APPROX. 1000	LOW AND WIDE DISH	400	35-40	3-5
CHEESE TOPPED ONION SOUP	2 X 200 G CUPS	SOUP BOWLS	400	2-4	3-5

Before using a dish in the microwave oven make sure that it is suitable for microwave use. Only use dishes or containers that are suitable for microwave use.

The dish to be used in the combined function must be suitable for microwave and grill use. See the section on types of overware!

Keep in mind that the figures given are merely indicative and can vary as a function of the initial state, temperature, moisture and type of food.

If the time is not enough to brown the food well, put it under the grill for another 5 or 10 minutes.

Please follow the standing times and don't forget to turn the meat pieces.

Unless indicated to the contrary, use the turntable plate for cooking.

The values given in the tables are valid when the oven cavity is cold (it is not necessary to pre-heat the oven).

9.4 Pizza Function

Warning! Read the section "Using the browning plate" before cooking with the Pizza function.

It is not necessary to pre-heat the browning plate to cook Pizzas.

Place the pizza directly on the browning plate.

Place the browning plate on the centre of the glass turntable in the microwave oven.



Instructions for the User

Warning: the cavity walls and the browning plate become very hot. Care should be taken to avoid touching heating elements, cavity walls or the browning plate. The use of oven gloves is highly recommended to avoid burns.

9.5 What kind of ovenware can be used?

9.5.1 Microwaves function

For the microwave function, keep in mind that microwaves are reflected by metal surfaces. Glass, china, clay, plastic, and paper let microwaves pass. For this reason, metal pans and dishes or containers with metal parts or decorations cannot be used in the microwave. Glass ware and clay with metallic decoration or content (e.g. lead crystal) cannot be used in microwave ovens.

The ideal materials for use in microwave ovens are glass, refractory china or clay, or heat resistant plastic. Very thin, fragile glass or china should only be used for short period of times (e.g. heating).

Hot food transmits heat to the dishes which can become very hot. You should, therefore, always use an oven glove!

To test ovenware, put the item you want to use in the oven for 20 seconds at maximum microwave power. After that time, if it is cold or just slightly warm, it is suitable to use. However, if it heats up a lot or causes electric arcing it is not suitable for microwave use.

9.5.2 Grill Element

In the case of the grill function, the ovenware must be resistant to temperature of at least 300°C.

Plastic dishes are not suitable for use in the grill.

9.5.3 Combination functions

In the combination functions (microwaves + conventional heating elements), the ovenware used must be suitable for use in both the microwave and the grill.

9.5.4 Aluminium containers and foil

Pre-cooked food in aluminium containers or in aluminium foil can be put in the microwave if the following aspects are respected:

- Keep in mind the manufacturer's recommendations written on the packaging.
- The aluminium containers cannot be more than 3 cm high or come in contact with the cavity walls (**minimum distance 3 cm**). Any aluminium lid or top must be removed.
- Put the aluminium container directly on top of the turntable plate. If you use the grid iron, put the container on a china plate. Never put the container directly on the grid iron!
- The cooking time is longer because the microwaves only enter the food from the top. If you have any doubts, it is best to use only dishes suitable for microwave use.
- Aluminium foil can be used to reflect microwaves during the defrosting process. Delicate food, such as poultry or minced

Instructions for the User



EN

meat, can be protected from excessive heat by covering the respective extremities/edges.

- **Important:** aluminium foil cannot come into contact with the cavity walls since this may cause electrical arcing.

9.5.5 Lids

We recommend you use glass or plastic lids or cling film since:

1. This will stop excessive evaporation (mainly during very long cooking times);
2. The cooking times are shorter;
3. The food does not become dry;
4. The aroma is preserved.

The lid should have holes or openings so that no pressure develops. Plastic bags must also be opened. Baby feeding bottles or jars with baby food and similar containers can only be heated without their tops / lids otherwise they can burst.

The table below gives you a general idea of what type of ovenware is suitable for each situation.

OPERATINGMODE TYPEOF OVENWARE	MICROWAVE		GRILL	MICROWAVE + GRILL
	DEFROSTING / HEATING	COOKING		
<u>GLASS AND CHINA 1)</u> HOME USE, CAN BE USED IN DISH WASHER, NOT FLAME RESISTANT	YES	YES	NO	NO
<u>GLAZED CHINA</u> FLAME RESISTANT GLASS AND CHINA	YES	YES	YES	YES
<u>CHINA, STONE WARE 2)</u> UNGLAZED OR GLAZED WITHOUT METALLIC DECORATIONS	YES	YES	NO	NO
<u>CLAY DISHES 2)</u> GLAZED	YES	YES	NO	NO
	NO	NO	NO	NO
<u>PLASTIC DISHES 2)</u> HEAT RESISTANT TO 100°C	YES	NO	NO	NO
HEAT RESISTANT TO 250°C	YES	YES	NO	NO
<u>PLASTIC FILMS 3)</u> PLASTIC FILM FOR FOOD	NO	NO	NO	NO
CELLOPHANE	YES	YES	NO	NO
<u>PAPER, CARDBOARD, PARCHMENT 4)</u>	YES	NO	NO	NO
<u>METAL</u> ALUMINIUM FOIL	YES	NO	YES	NO
ALUMINIUM WRAPPINGS 5)	NO	YES	YES	YES
ACCESSORIES (GRID IRON)	NO	NO	YES	YES

1. Without any gold or silver leaf edging; no lead crystal.
2. Keep the manufacturer's instructions in mind!
3. Do not use metal clips for closing bags. Make holes in the bags. Use the films only to cover the food.
4. Do not use paper plates.
5. Only shallow aluminium containers without lids/tops. The aluminium cannot come into contact with the cavity walls.



Instructions for the User

10 CLEANING AND MAINTENANCE



Before carrying out any operations, disconnect the appliance from the electricity supply. Take the plug out of the socket or switch off the oven's power circuit.



Warning! Never use a jet of steam for cleaning the inside of the oven.



Warning! Your microwave oven should be cleaned regularly, with all food remains being removed. If the microwave is not kept clean its surfaces may deteriorate, reducing the oven's working life and possibly resulting in a dangerous situation.

10.1 Cleaning stainless steel



To keep stainless steel in good condition, it must be cleaned regularly, after each use of the oven, after allowing it to cool.

10.2 Routine daily cleaning

When cleaning and caring for stainless steel surfaces, always use **only** specific products which do not contain abrasives or chlorine-based acids.

Instructions for use: pour the product onto a damp cloth and wipe over the surface, then rinse thoroughly and dry with a soft cloth or chamois leather.

10.3 Food stains or spills

Never use metal scouring pads or sharp scrapers which will damage the surface.

Use ordinary non-abrasive products with the aid of wooden or plastic utensils if necessary. Rinse thoroughly and dry with a soft cloth or chamois leather.

Do not allow spills of foods with high sugar content (e.g. jam) to dry inside the oven. If they dry for too long, they might damage the enamel coating of the inside of the oven.

Do not use harsh abrasive cleaners or sharp metal scrapers to clean the oven door glass since they can scratch the surface, which may result in shattering of the glass.

10.4 Cleaning the oven cavity

Cleaning is the only maintenance normally required.

After each time the oven is used, clean the inside walls with a damp cloth since this is the easiest way to remove splashes or spots of food that may have stuck to the inside.

To remove dirt that is harder to shift, use a non-aggressive cleaning product. Do not use oven sprays or other aggressive or abrasive cleaning products.



Instructions for the User



EN

Always keep the door and the oven front very clean to ensure that the door opens and closes properly.

Make sure water does not enter the microwave ventilation holes.

Regularly take out the turntable plate and the respective support and clean the cavity base, especially after any liquid spillage.

Do not switch on the oven without the turntable and the respective support being in place.

If the oven cavity is very dirty, put a glass of water on the turntable and switch on the microwave oven for 2 or 3 minutes at maximum power. The steam released will soften the dirt which can then be cleaned easily using a soft cloth. Unpleasant odours (e.g. after cooking fish) can be eliminated easily. Put a few drops of lemon juice in a cup with water. Put a spoonful of coffee in the cup to avoid the water boiling over. Heat the water for 2 to 3 minutes at maximum microwave power.

10.5 Cleaning the cavity ceiling

If the oven ceiling is dirty, the grill can be lowered to make cleaning easier.

To avoid the danger of burning, wait until the grill is cold before lowering it.

Proceed as follows:

1. Turn the grill support by 180° (1).
2. Lower the grill gently (2). **Do not use excessive force as this may cause damage.**
3. After cleaning the ceiling, put the grill (2) back in its place, carrying out the previous operation.

IMPORTANT WARNING: The grill heating element support (1) may fall when it is rotated. If this happens, insert the grill heating element support (1) into the slot in the ceiling of the cavity and rotate it 90° to the grill heating element support (2) position.

The mica cover (3) located in the ceiling must always be kept clean. Any food remains that collect on the mica cover can cause damage or provoke sparks.

Do not use abrasive cleaning products or sharp objects.

To avoid any risk, do not remove the mica cover.

The glass lamp cover (4) is located on the oven ceiling and can be removed easily for cleaning. For this you just need to unscrew it and clean it with water and dishwashing liquid.

10.6 Cleaning the accessories

Clean the accessories after each use. If they are very dirty, soak them first of all and then use a brush and sponge. The accessories can be washed in a dish washing machine.

Make sure that the turntable plate and the respective support are always clean. Do not switch on the oven unless the turntable and the respective support are in place.



Instructions for the User

11 EXTRAORDINARY MAINTENANCE

Occasionally, the oven will require minor servicing procedures or the replacement of parts subject to wear and tear, such as gaskets, light bulbs, etc. The specific operations for each procedure of this kind are provided below.



Before carrying out any operation involving access to live parts, disconnect the appliance from the electricity supply.

11.1 Changing the light bulb

To change the light bulb, proceed as follows:

- Unscrew and remove the glass light cover (1).
- Remove the halogen light bulb (2).
Warning! The bulb may be very hot.
- Fit a new 12V / 10W halogen bulb.
Warning! Do not touch the light bulb surface directly with your fingers because you may damage the bulb. Follow the lamp manufacturer's instructions.
- Screw the glass light cover into place (1).
- Connect the oven again to the power supply.

11.2 What should I do if the oven doesn't work?

WARNING! Any type of repair must only be done by a specialised technician. Any repair done by a person not authorised by the manufacturer is dangerous.

You do not need to contact Technical Assistance to resolve the following questions.

The display is not showing! Check if:

- The time indication has been switched off (see section on Basic Settings).

Nothing happens when I press the keys! Check if:

- The Safety Block is active (see section on Basic Settings).

The oven does not work! Check if:

- The plug is correctly fitted in the socket.
- The oven's power is switched on.
- The door is completely closed. The door should close with an audible click.

Instructions for the User



EN

- There are any foreign bodies between the door and the cavity front.

When the oven is operating I can hear some strange noises! Check if:

- There is any electrical arcing inside the oven caused by foreign metallic objects (see section on type of ovenware).
- The ovenware is touching the oven walls.
- There are any loose items of cutlery or cooking tools inside the oven.

The food doesn't heat up or heats very slowly! Check if:

- You have inadvertently used metal ovenware.
- You have selected the correct operating times and power level.
- The food you have put inside the oven is a larger amount or colder than you usually put in.

The food is too hot, dried out or burnt! Check if:

- You selected the correct operating time and power level.

I hear some noises after the cooking process is finished!

- This is not a problem. The cooling fan keeps on working for some time. When the temperature has dropped sufficiently, the fan will switch itself off.

The oven switches on but the interior light does not go on!

- If all the functions work properly it is probable that the lamp has blown. You can keep on using the oven.



Instructions for the Installer

12 INSTALLING THE APPLIANCE

12.1 Electrical connection



The nameplate with the technical data, serial number and mark is in a visible position on the oven door frame.

The nameplate must never be removed.



The appliance must be connected to earth in compliance with electrical system safety regulations.



If a permanent connection is used, the appliance's power supply line must be fitted with an omnipolar breaking device with contact gap of at least **3 mm**, located in an easily accessible position close to the appliance itself.



If a socket and plug connection is used, check that they are of the same type. Do not use reducers, adapters or junctions since they may cause overheating or burns.



12.2 Positioning the oven

The appliance is designed for building-in to cabinets made from any heat-resistant material. Comply with the dimensions shown in following pictures. When installing in tall units bear in mind that the top/rear of the unit must have an opening 100 mm deep.

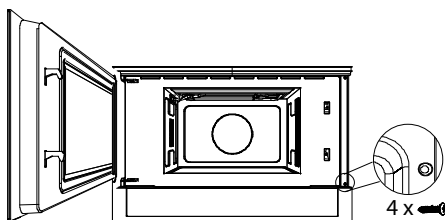
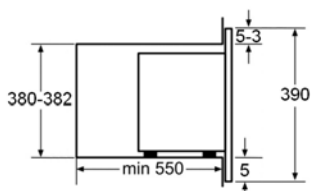
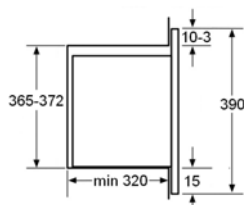
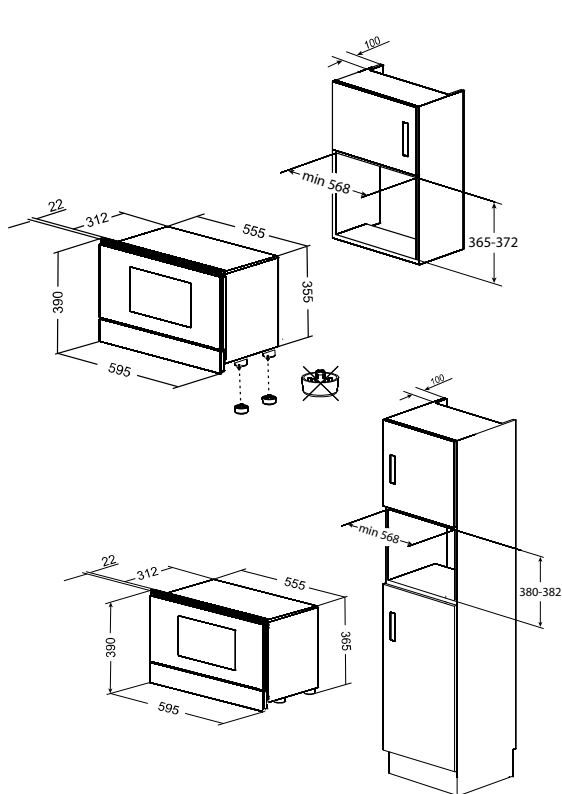

EN

- Push oven completely into the cabinet and centre it.
- Open microwave door and fasten the appliance to the cabinet using the four screws provided.